

Cube Core 2" Filter Grille

DARE5-FG2 **Top & Bottom Mounting**

MOUNTING OPTIONS – A, B, C OR D
Must Specify Both



- 1/2"x 1/2"x 1/2" eggcrate core has a high free area for minimum pressure loss
- Designed to fit most 2" filters (must be undersized 9/32")
- Neat appearance often matches luminaries
- Aluminum extruded frame with mechanically locked corners
- Available on 2" increments as standard
- Custom sizes available but extra charge may apply
- Durable powdercoat painted finish
- Available in White, Silver or Mill

TOP MOUNTING METHOD SPECIFIED FIRST (RECOMMENDED A & B ONLY)

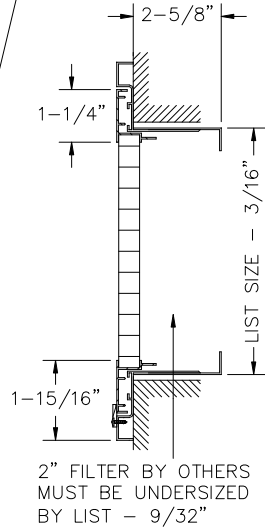
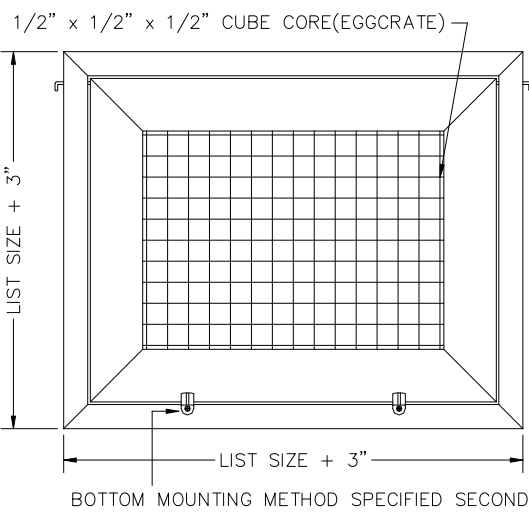

A SPRING PINS

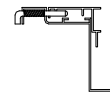
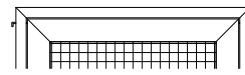

Grille easily removed from frame (recommended for top mounting only)

B WIRE HINGE

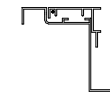
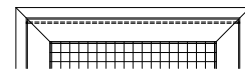

Grille NOT removable from frame (recommended for top mounting only)

C NYLON THUMBSCREW

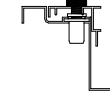
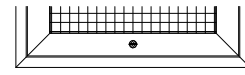

D NYLON SCREEN TABS

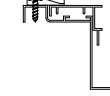
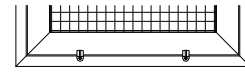

• **Note: DARE5-FG2 A&D shown**

• **Note:** 1+Filter can be specified by changing the suffix to -FG
 4+Filter can be specified by changing the suffix to -FG4



DESCRIPTION	DARE5-FG2 <small>Top & Bottom Mounting</small>
FACE BLADES	1/2"x 1/2"x 1/2" eggcrate
REAR BLADES	n/a
DAMPER	n/a
MATERIAL	Aluminum
COLOR	White/Silver/Mill

JOB NAME: _____

LOCATION: _____

ARCHITECT: _____

ENGINEER: _____

CONTRACTOR: _____